

DALI Professional

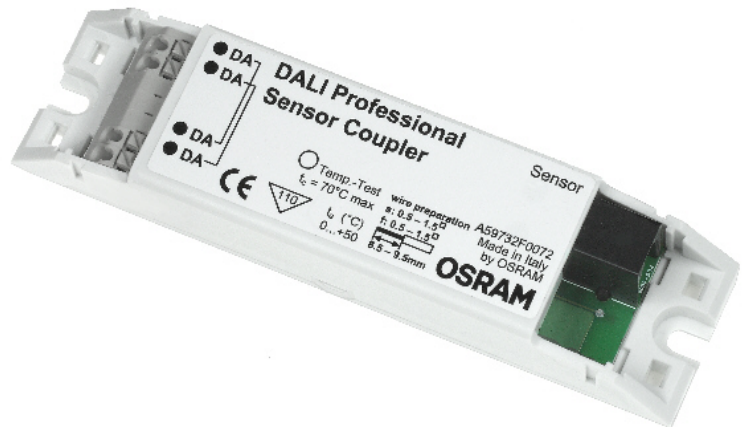

Frequently Asked Questions



DALI PROFESSIONAL Frequently Asked Questions

What is the max. cable length in OSRAM DALI PROFESSIONAL system?

Is it 300 m in total for all 4 DALI lines or 300 m per each DALI line?

DALI lines are released for 300 m with 1.5 mm² standard copper installation wires. The DALI PROFESSIONAL controller CONT-4 provides 4 electrical independent DALI lines which can be wired in opposite directions with the CONT-4 in the center.

What is the wiring concept for DALI projects?

DALI line topology is linear or star up to 300 m max. distance at min. 1.5 mm² copper wire. But no closed loops, no ring topology. Do not mix with TOUCH DIM applications. Avoid shortcuts. DALI wiring needs only basic insulation to mains voltage, so standard installation cable NYM 5x1,5 mm² is recommended.

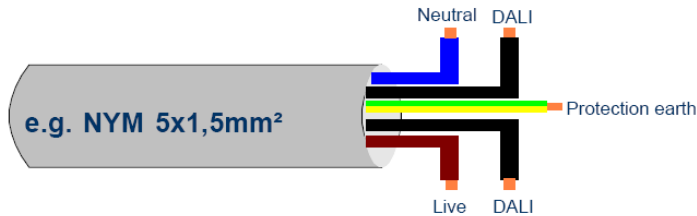

How many DALI ECGs can be used?

In DALI there are 64 DALI ECG addresses per DALI line which results in 128 mA DALI current consumed by these ECGs. Because we have 4 DALI lines in DP CONT-4, there can be used max. 256 ECGs.

For ECG with more addresses per unit (e.g. OSRAM OTi DALI 75 with optional 4 addresses) the max. number is reduced accordingly.

How many DALI ECGs can be controlled individually in OSRAM DALI PROFESSIONAL?

DALI PROFESSIONAL provides in total 256 DALI ECG addresses divided into 4 DALI lines. To control these individually you need 256 buttons or 64 pushbutton couplers which exceeds the maximum DALI current. With this you can only control 220 ECGs individually. To achieve a full individual control of all 256 ECGs, we recommend to use 22 Glasstouches (12 buttons each) combined with the according e:bus gateways / power supplies.

How many DALI input devices can be used?

In our system there are 64 DALI Input Devices addresses per DALI line. Because there are 4 DALI lines in DALI PROFESSIONAL Controller CONT-4 max. 800 mA DALI current can be used in total including the ECGs. This leaves approx. 280 mA for Input Devices if all 256 ECGs are installed. The remaining DALI current to be consumed by input devices depends on mix of types (OSRAM DALI Pushbutton Coupler 6 mA, OSRAM DALI Sensorcoupler 5 mA). For input devices with more addresses per unit (e.g. OSRAM DALI Sensorcoupler with 2 addresses), the maximum devices number by addresses is reduced accordingly.

How many pushbuttons can be used in OSRAM DALI PROFESSIONAL?

Final number is depending on mix of products in the configuration. Theoretical there are 64 input device addresses per DALI line. But in most applications the limiting factor is the current : each DALI line of CONT-4 provides 200 mA DALI current which has to be shared between ECGs and input devices. So if all 64 ECGs are installed you can add 12 OSRAM DALI Pushbutton Couplers (48 buttons) or 7 OSRAM DALI Pushbutton Couplers (28 buttons) and 5 OSRAM DALI Sensorcouplers (5 light sensors + 5 occupancy sensors).

How many sensors can be used in OSRAM DALI PROFESSIONAL?

Final number is depending on mix of products in the configuration. Theoretical there are 64 input device addresses per DALI line. But in most applications the limiting factor is the current : each DALI line of CONT-4 provides 200 mA DALI current which has to be shared between ECGs and input devices. So if all 64 ECGs are installed you can add 14 OSRAM DALI Sensorcouplers (14 lightsensors + 14 occupancy sensors) or 7 OSRAM DALI Pushbutton Couplers (28 buttons) + 5 OSRAM DALI Sensorcouplers (5 lightsensors + 5 occupancy sensors).

What is the maximum pushbutton distance to OSRAM DALI Pushbutton Coupler?

We allow a maximum wiring length of 2 m from pushbutton to OSRAM DALI Pushbutton Coupler. We recommend to install the pushbutton coupler behind the pushbutton in an installation box using the wires delivered with the device.

What is the maximum sensor distance to OSRAM DALI Sensorcoupler?

A maximum wiring length of 5 m from Sensor to OSRAM DALI Sensorcoupler is allowed. Recommended is OSRAM MULT13 wiring material like Y-Connector.

How many DALI groups can be configured?

In DALI an ECG is able to store up to 16 group affiliations. OSRAM DALI PROFESSIONAL Controller CONT-4 provides 4 DALI lines, so there are maximum 64 DALI groups. In case of group overlap from one DALI line to another the same group is used two times. With this the maximum number is reduced by one. If the maximum number of groups is used up the controller creates automatically additional virtual groups by sending serial addressed commands. But the reaction time / synchronisation can be effected.

How many DALI scenes can be configured?

In DALI an ECG is able to store up to 16 scene values. OSRAM DALI PROFESSIONAL Controller CONT-4 provides 4 DALI lines, so there are maximum 64 scenes. In case of scene overlap from one DALI line to another the same scene is used two times and the maximum number is reduced by one. If more than 16 scenes per DALI line are used there will be an error message. Using additional virtual scenes with DALI would lead to unacceptable delays and asynchronous behaviour. We recommend for complex animations to use OSRAM EASY system where the sequences are stored in the ECG. Even bigger installations can be made with DMX systems from traxon / e:cue.



For what reason we recommend to use 230V buttons / switches for OSRAM DALI Pushbutton Coupler input contacts?

There is no technical reason for that, also a 12 V bell button would work, but there are regulations. DALI wiring needs only basic insulation, therefore it has to be handled like mains voltage. The wallbox geometry of the pushbutton coupler does not allow to design the necessary safety distances. For this reason also the connected buttons have to be handled like mains voltage devices.

Is there a possibility to control the lights by PC?

The PC connection in OSRAM DALI PROFESSIONAL system is only designed for setup process and configuration, not for permanent use in the application. But via a PC output (e.g. I/O card with dry contact relay) input events can be generated to the pushbutton coupler which can start actions in the DALI system.

How can I backload a project from the controller?

Connect controller by USB with PC, click to the connection symbol . Click to download from controller symbol  to retrieve existing configuration from controller. Works only if project is uploaded before with Software DALIpro ≥ v1.3.0.0.

Can I check the device status during system operation?

There is no visualisation of single device status after the setup is finished and the controller is disconnected from PC. But the LEDs on controller front show lamp errors and DALI shortcuts per DALI line. The DALI PROFESSIONAL PC screen / GUI is only designed as a tool for setup, not for monitoring a running application. If this functionality is requested another system type has to be used. In building management systems based on KNX, LON, BacNet this feature is usually existing and the status is possible to be shown online on a central screen.

How can I integrate a remote control into OSRAM DALI PROFESSIONAL system?

Use the OSRAM TOUCH DIM RC device as receiver and connect the output contacts to a OSRAM DALI Pushbutton Coupler. The RF signal can be generated from any Enocean button signal source. One OSRAM TOUCH DIM RC can handle two Enocean channels.

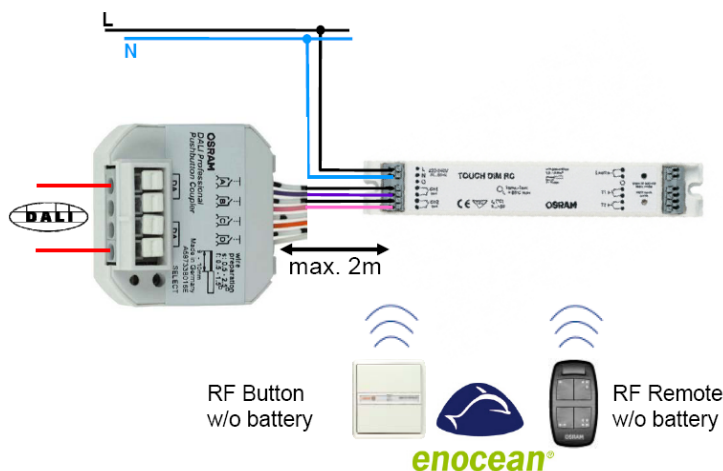

What is the standby wattage of the system?

Standby power demand per DALI ECG 1-/2-lamp is 200 mW, for 3-/4-lamp it is 500 mW



DALI PROFESSIONAL Controller CONT-4 incl. all DALI supplied couplers consumes 10..25 W depending on the usage. The controller shows no real standby status because there are many processes in the background even if all ECGs are switched off by DALI.

How can I integrate parallel a group of switching sensors?

A) Electrical Solution

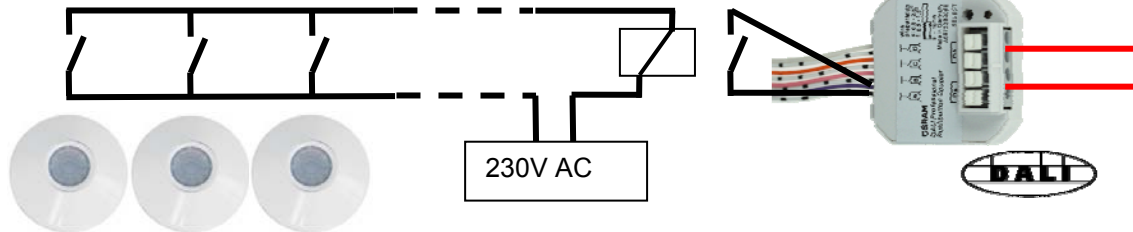

B) Software Solution in DALIpro GUI

Put all switches into one function and define 'switch linkage' = parallel in Properties / General.

Can I use other input devices than from OSRAM?

Yes, the Siemens DALI Multi Sensor Office 5WG 141-2AB51 is electrical identical to OSRAM DALI Sensorcoupler. Only label and GTIN = EAN10 stored in the coupler are different.

Also the Siemens DALI Pushbutton Coupler 5WG 141-2AB71 can be used in the OSRAM system.

Is it possible to switch ON/OFF a CONT-4 controller relay K1 with a lightsensor?

You cannot switch ON/OFF with OSRAM DALI Sensorcoupler because the lightsensor is only used for regulation. For switch function we use the PIR sensor with movement. But to generate a dusk / dawn switch here the trick : Use an external dawn sensor with switched output (must be dry contact, not mains connected) and take this as an input to DALI Pushbutton Coupler which is configured as switch.

Can OSRAM DALI SWITCH SO be used with other systems than DALI PROFESSIONAL?

OSRAM DALI SWITCH SO is not only made for use in DALI PROFESSIONAL. It is working similar to an ECG, means if a DALI controller sends a DALI command with dimmlevel > 1 all 3 relays switch ON, with dimmlevel = 0 they switch OFF.

Which USB cable do I need to connect DALI PROFESSIONAL to PC?

The connection from OSRAM DALI PROFESSIONAL Controller to PC is made with USB cable Typ A/B, see picture



Usually a PC / notebook provides type A socket (rectangular connector, see left side of picture). The DALI controller USB input is type B (square connector, see right side of picture).

What is a regulation factor?

The regulation factor is a measure for the split of artificial / natural light in the room in relation to light sensor position. There are detailed algorithms behind and 2.8 is a standard value for an office. The regulation factor can be calibrated optional for each application, but this method is made for specialists which need extra accurate regulation. For standard use cases it is not necessary to calibrate the regulation factor.

How many regulations can be used in the DALI PROFESSIONAL system?

Up to 32 light regulations can be handled in a OSRAM DALI PROFESSIONAL controller CONT-4. If more light sensors are requested, up to 10 light sensors can be used together in one regulation. The according PIR sensors can be used separately without restrictions. Many regulations running with fast changes at the same time can delay the reaction time.

How can I sort all these many functions on the screen?

Use up and down arrows on right upper Graph screen corner to move the selected function / group on the screen. Use subdivisions like rooms (zones) in the tree to get a better overview in large projects.

What happens if a controller gets defect and how to replace?

If a controller gets defect the DALI voltage is missing. With this all connected ECGs will show the System-Failure Mode which results by factory setting in 100% light.

To replace the controller : install new controller, replace wiring 1:1

Open stored configuration from PC [xxxx.osrdpc](#), upload to controller with 

The ECGs / DALI couplers keep their stored short address and with this all previous functions are copied to the correct devices.

How can I reset the whole system to factory settings?

Enter Plug&Play Mode by uploading an empty configuration to the controller.

Then press on controller ON/OFF/DIM until POWER LED is blinking (approx. 10 s) - all coupler addresses are deleted. ECG addresses are not deleted with this reset.

Do I need always a pushbutton controller to create a light regulation?

If you start and stop the regulation with the PIR you need no pushbutton coupler. Here a configuration example where the light is on during occupancy and switches off after 20 minutes with non-occupancy :

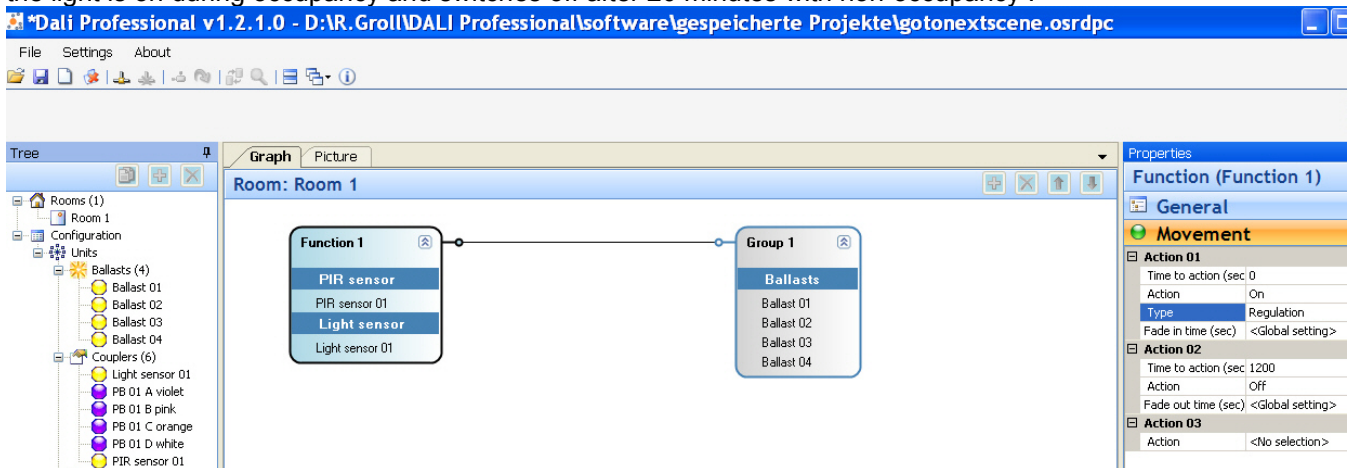

For practical reasons it is always an advantage if there are some additional pushbuttons to have a chance for manual control – e.g. if PIR sensor gets defect / dirty / shielded ...

What is the max. adjustable delay time

With DALIpro the maximum delay time between 2 actions is 360000s = 100h which enables e.g. the configuration of a 100h burn-in for T5 fluorescent lamps.

Is there a possibility to recall different scenes from external control systems?

Scenes can be recalled externally if these are triggered via pushbutton coupler. One external output (relay dry contact) is necessary per scene or use of next scene action type. The scenes have to be configured before in the DALIpro setup.

DALI PROFESSIONAL INSTALLATION HINTS

DALI wiring general

- 2 wires minimum 1.5 mm², max. 300 m, linear / star topology, basis insulation
- no mains voltage on DALI wires
- first solve wiring problems, then start setup procedure (to enable correct communication)

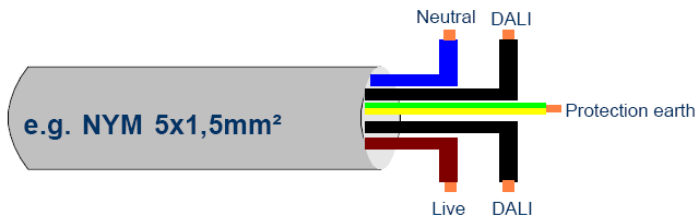

Pushbutton Coupler wiring

mains voltage on DALI wires can destroy the device

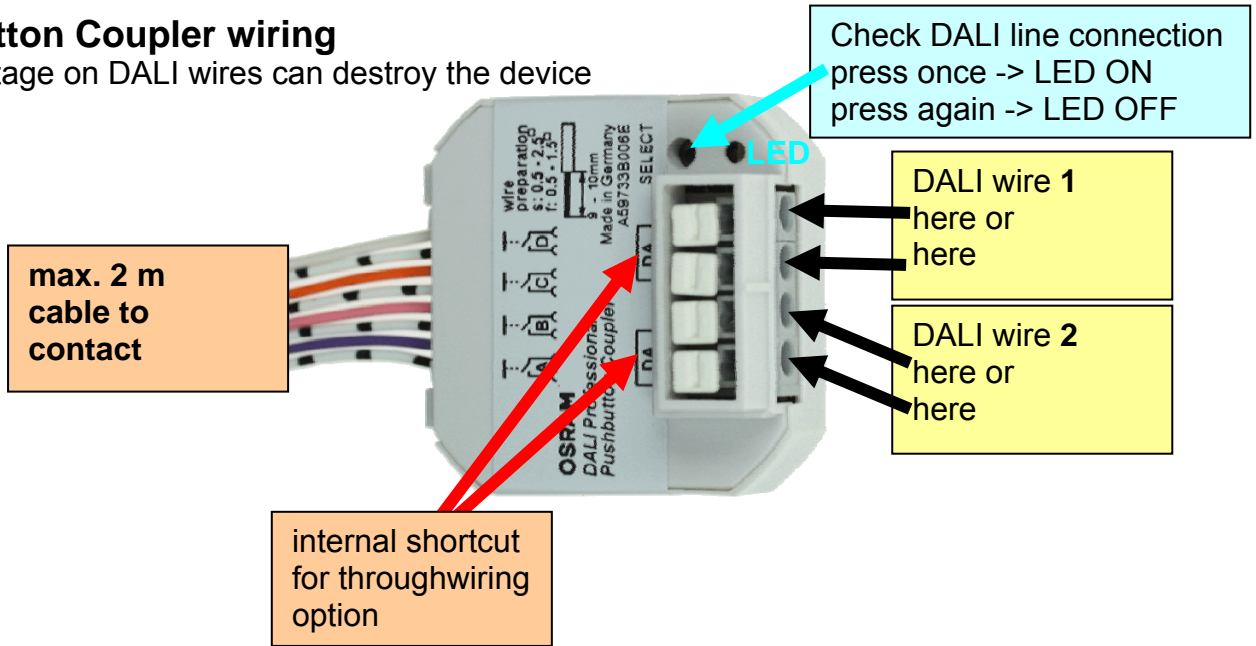

Sensor Coupler wiring

- Mains voltage on DALI wires can destroy the device
- 1 Sensor per Sensorcoupler
- distance lightsensor to measurement area 2..5 m

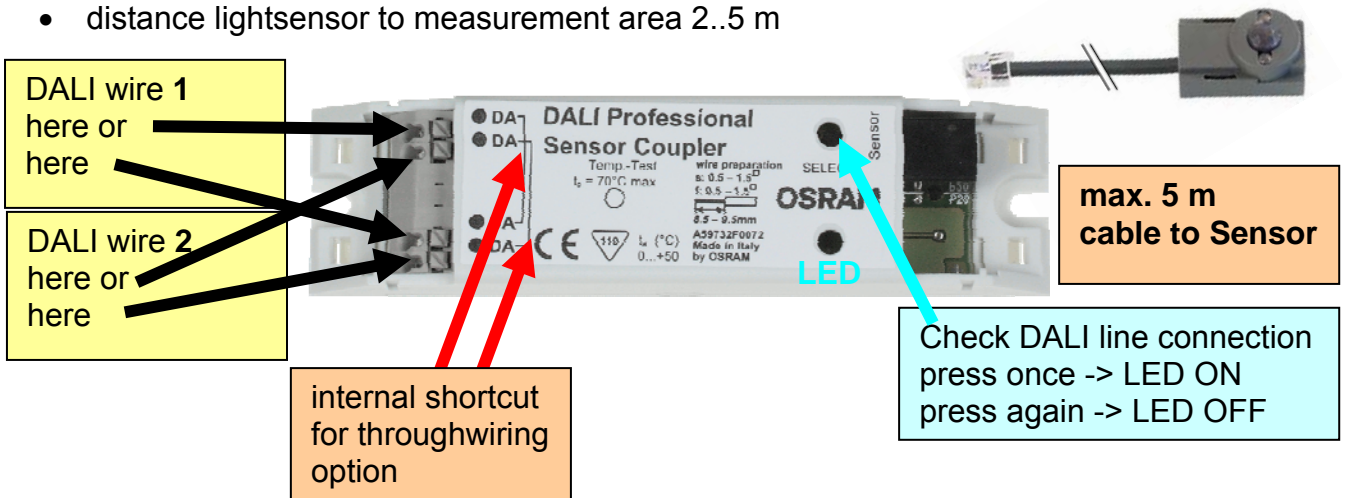

Installation Hints DALI Pushbutton Coupler

Mounting Pushbutton Coupler

- do not install in cabinet with a long wiring to pushbuttons
- recommended for integration into wallbox and direct connection to DALI

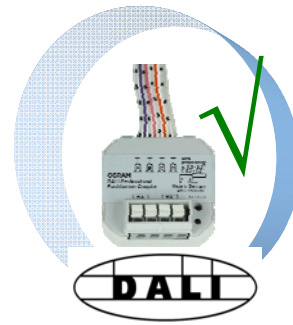
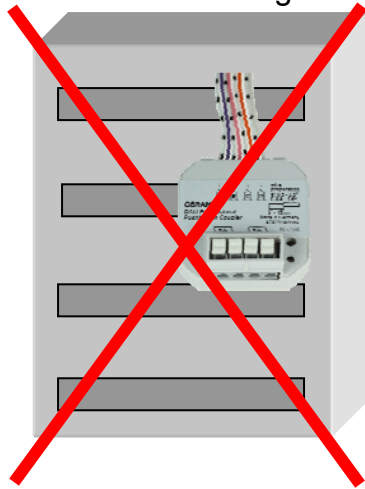

- use only one coupler input per external button / switch

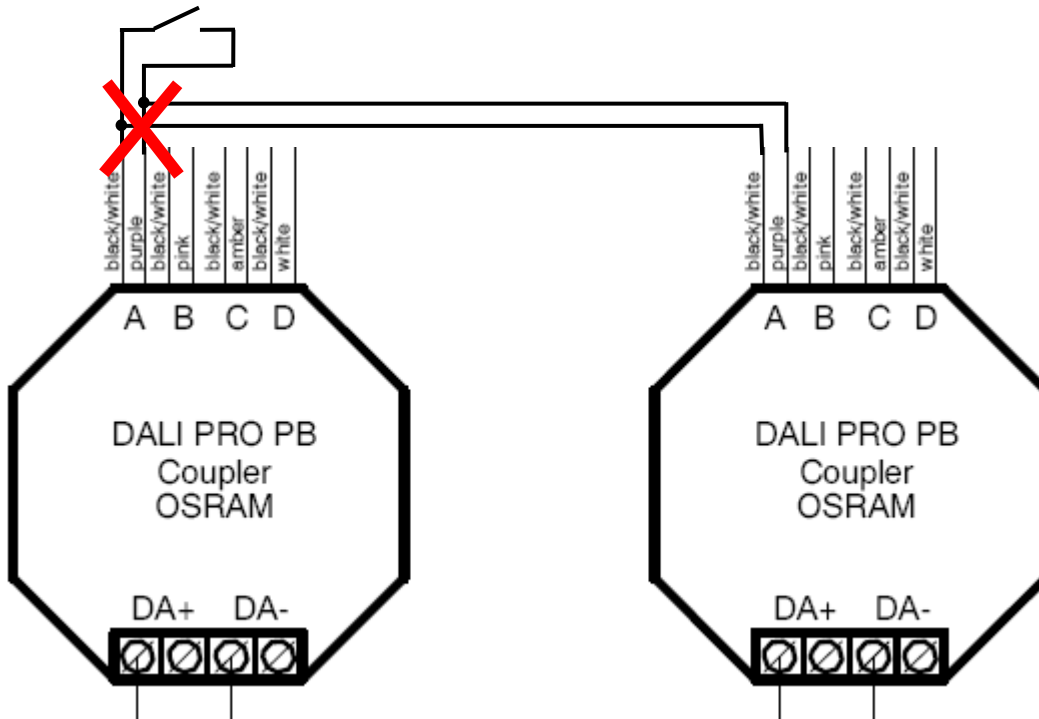

Installation Hints DALI Sensorcoupler

Mounting of Sensorcoupler outside of a Luminaire
with ECO CI KIT EAN 4008321392091

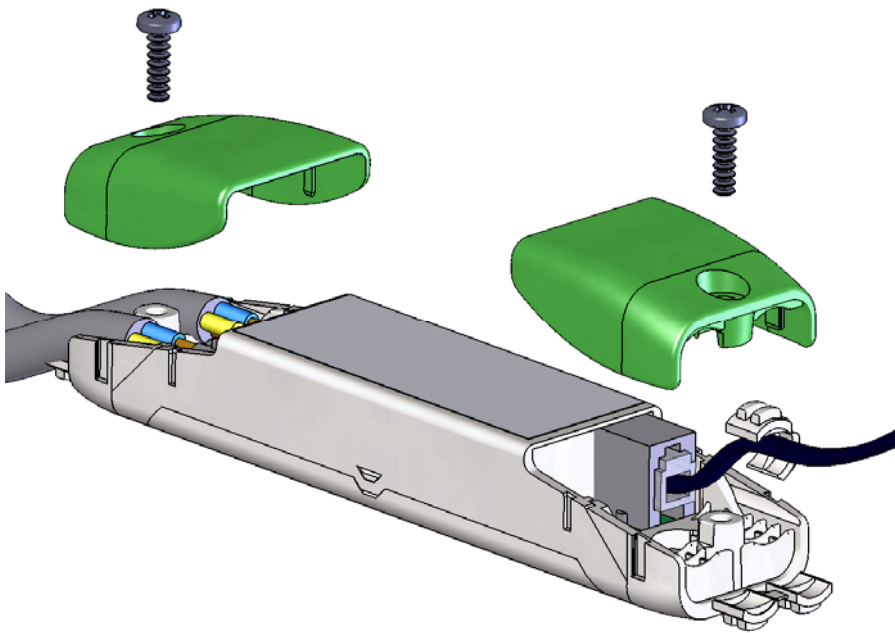

Mounting of Sensor LS/PD outside of Luminaire

Ceiling Integration
LS/PD MULTI3 CI EAN 4008321916648



Ceiling Mounting
additional with SENSOR KIT EAN 4008321916662



Application Hints DALI PROFESSIONAL Controller CONT-4

Firmware upgrade via DALIpro software

- Also possible on desk without mains voltage only supplied via USB
- Upgrade process finished
 - > Restart by mains voltage interruption + USB disconnection + restart software

Operation modes without PC :

Construction site mode for testing

- SELECT button for choice of DALIport / relay
- ON/OFF/DIM for TouchDIM functionality
- LED for visualisation of status (see manual)

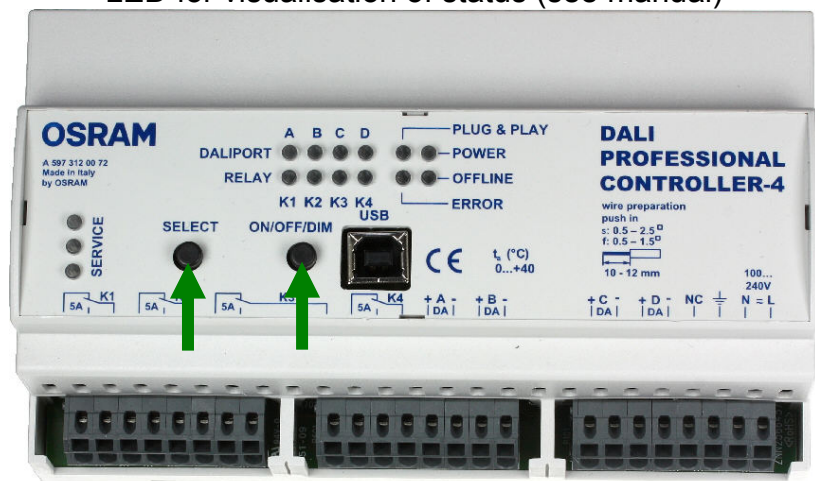

Plug&Play mode

- Toggle function for each button to all ECGs in the same DALI line (ON/OFF/DIM; TouchDIM functionality)

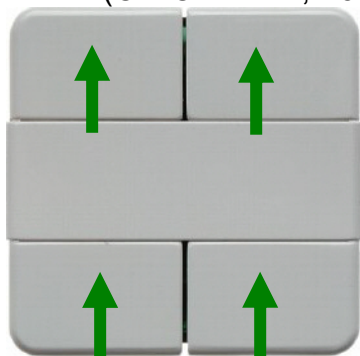

- Automatic occupancy detection with PIR or LS/PD Sensor / Sensorcoupler Switches On all ECGs in the same DALI line
5 minute off-delay when no more occupancy detected

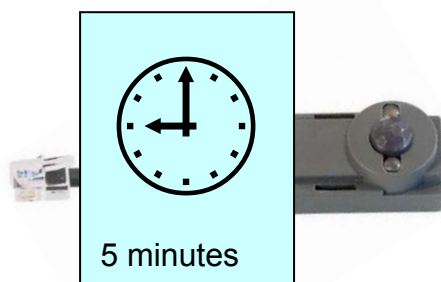

Installation Hints Controller CONT-4

Install Circuit Breaker on DINrail beside Controller (for mains interruption at upgrade / reset)



Real Time Clock Applications :

Install external timer (clock) + pushbutton coupler to get time synchronized sequences started

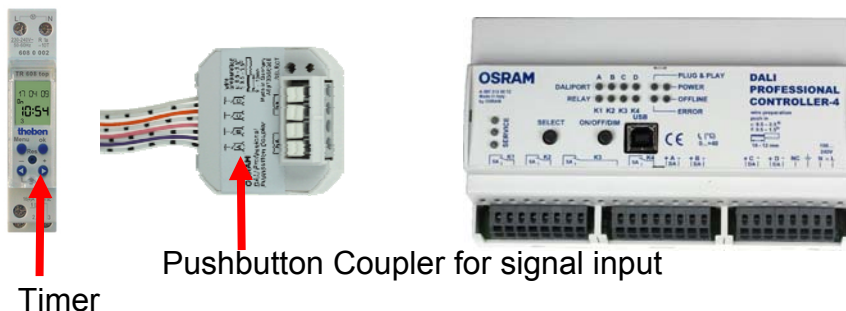

DALI PROFESSIONAL - extended / wireless setup

for transmission of the USB signal to LAN :

BELKIN Network USB Hub F5L009

Wired Hi-Speed USB Device Server

Gateway USB -> LAN



to get WLAN access use in in combination with :

DLINK DAP-1160

Wireless G Open Source Repeater

Gateway LAN -> WLAN



DALI Professional System features with DALIpro Software

Limits, maximum values per DALI PROFESSIONAL Controller CONT-4

- 4x maximum 64 ECG addresses
- 4x maximum 64 input device addresses (sensors / pushbuttons)
- Current limitation 200 mA per DALI port
 - > total limit of number of ECGs + input devices depending on mix
- 4x max. 300 m DALI line length, wires $\geq 1.5 \text{ mm}^2$
- max. 5 m Sensor to Sensorcoupler
- max. 5 m Lightsensor distance to measurement area (depending on reflection characteristic)
- max. 2 m Pushbutton to Pushbutton Coupler
- 4x 16+ Groups, line overlapping allowed
 - '+' means additional 'virtual' groups possible by software, but uses addressed commands
 - Maximum number of groups only limited by controller memory
- 4x 16 Scenes, line overlapping allowed, but then one scene used for each line
- 4x 8 active light regulation loops
 - more possible when noticeable delay accepted, limited by reaction times
- 4x switch-over relais maximum 5 A ohmic load each

System Features

- out-of-the-box plug & play functionality if no configuration loaded
- full- and semi-automatic energy saver function with occupancy- and light-sensor
- up to 10 lightsensors / sensorcouplers per regulation
- corridor function with unlimited steps
- PIR disable / enable function
- sequences consisting of scenes, fade control, loops
- scene stepping
- visible resource status message
- switch function e.g. for Highbay Sensor integration
- serial / parallel configuration of grouped switches
- programmable internal relay to be used in action list
- testfunction for all DALI devices
- configuration check against physical available devices
- simple 'failed ECG' replacement
- retrieve configuration by download from controller
- full project documentation in HTML file

Perfect for

- industry hall
- warehouse
- classrooms
- single office
- large office
- meeting room
- corridor